



La **Ilinox srl**, established in 1983, is a leading manufacturer of stainless steel metal structural work for control boards.

Certified ISO9001 since 1995 by a leading international Body, i.e. the DNV, Ilinox srl has successfully built-up over the years, thanks to highly skilled personnel and the use of state-of-the-art technologies, a highly specialized manufacturing and sales structure, focused on providing customers with first quality reliable services.

www.ilinox.com



EXPERIENCE ILINOX

Ilinox boasts over 30 years of field-acquired experience in over hundred countries worldwide. Leader in the design of control boards enclosures for cutting-edge processes, constantly targeted at satisfying specific market demand and customer's requirements.

Ilinox provides its customers with detailed and exhaustive documentation of the product, illustrating its specific applications as well as every operating aspect. This means that by purchasing an Ilinox product, you are always sure you will succeed in installing it quickly and efficiently, assured that the product has been designed and configured to provide exactly the performances you are expecting.

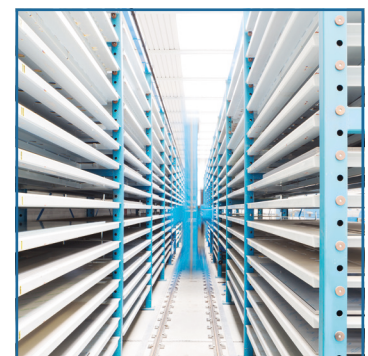



STAINLESS STEEL AND TECHNOLOGY

Choosing Ilinox enables to draw on the widest selection of stainless steel enclosures for control boards for the food and pharmaceutical industry so far available on the market. The excellent quality of our products guarantee unrivalled reliability, lifetime and cleanliness conditions.

Quality is a complex issue, for somebody it is just a matter of appearance. For others it is synonymous of product integrity and efficiency, or reliability of production and performances. Ilinox tries to pool all these aspects into a global idea of "quality" that involves the whole production process. The result of this approach generates the largest range of products and experience obtainable on the market, capable of helping you to preserve and improve your quality standard.





THE ENGINEERING SERVICE

Although a great number of products have been standardized, we have an engineering structure whose task is not only to study upgrading solutions for our mass production items, but also to provide our customers with valuable back-up service for tailored solutions to their specific problems.

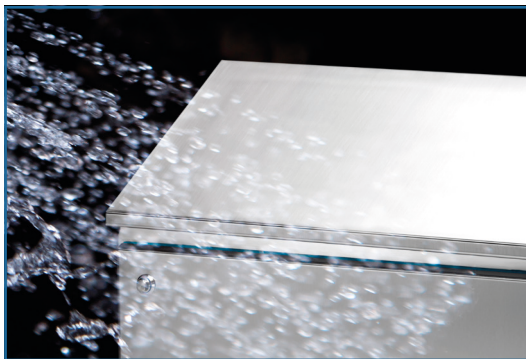

TESTS

Before reaching the market, all our products are carefully tested to check their tightness (protection degree), their earthing continuity, and their structural strength.





CERTIFICATIONS

Since 1995 Ilinox has been manufacturing under a Det Norske Veritas certified quality system, already updated since 2002 to the newly issued Directives ISO9001/2000. This achievement is regarded more as a start than a finish line: all core products are in fact certified UL (Nema 4-4X and Nema 12). Even the products not covered by this certification undergo stringent tests by authorized bodies.

IP66 IK10 IP69K			

Table 3 shows the protection degrees according to IEC rules 70-1 ed. 11/92. The degrees are identified by the acronym IP followed by two digits; the first digit indicates the degree of protection from dust, the second from liquids.

There is a variation in the application of degrees 7 and 8 as for liquid penetration: as a matter of fact, not always do these degrees imply also suitability for lower degrees (suitability which applies from degree IPX4 downwards).

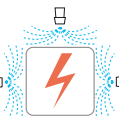
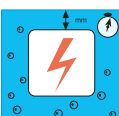
1 st DIGIT: PENETRATION OF SOLIDS			2 nd DIGIT: PENETRATION OF LIQUIDS		
0		Not protected	0		Not protected
1		Protected against solid bodies whose dim. are greater than 50mm ϕ	1		Protected against vertical fall of water drops
2		Protected against solid bodies whose dim. are greater than 12mm ϕ	2		Protected against rain with maximum inclination equal to 15°
3		Protected against solid bodies whose dim. are greater than 2,5mm ϕ	3		Protected against rain with maximum inclination equal to 60°
4		Protected against solid bodies whose dim. are greater than 1mm ϕ	4		Protected against sprinkling of water
5		Protected against dust	5		Protected against water jets with hurling from all directions
6		Totally protected against dust	6		Protected against waves
			7		Protected against the effects of immersion
			8		Protected against the effects of extended immersion

OUR PRODUCTS

We have the most comprehensive range available today on the market of stainless steel tight standard enclosures for electric, electronic, pneumatic and hydraulic equipment. We have an exhaustive stock of push-button panels, connector blocks, control boxes with hanging systems, compact, modular and computer cabinets. That is how we can assure fast deliveries while keeping constantly high quality standards.

“Thanks to an unmatched range of products and accessories, ilinox is confident about its capability of offering always the solutions you are looking for”

*Protection degree IP54
Consider filter + fan*

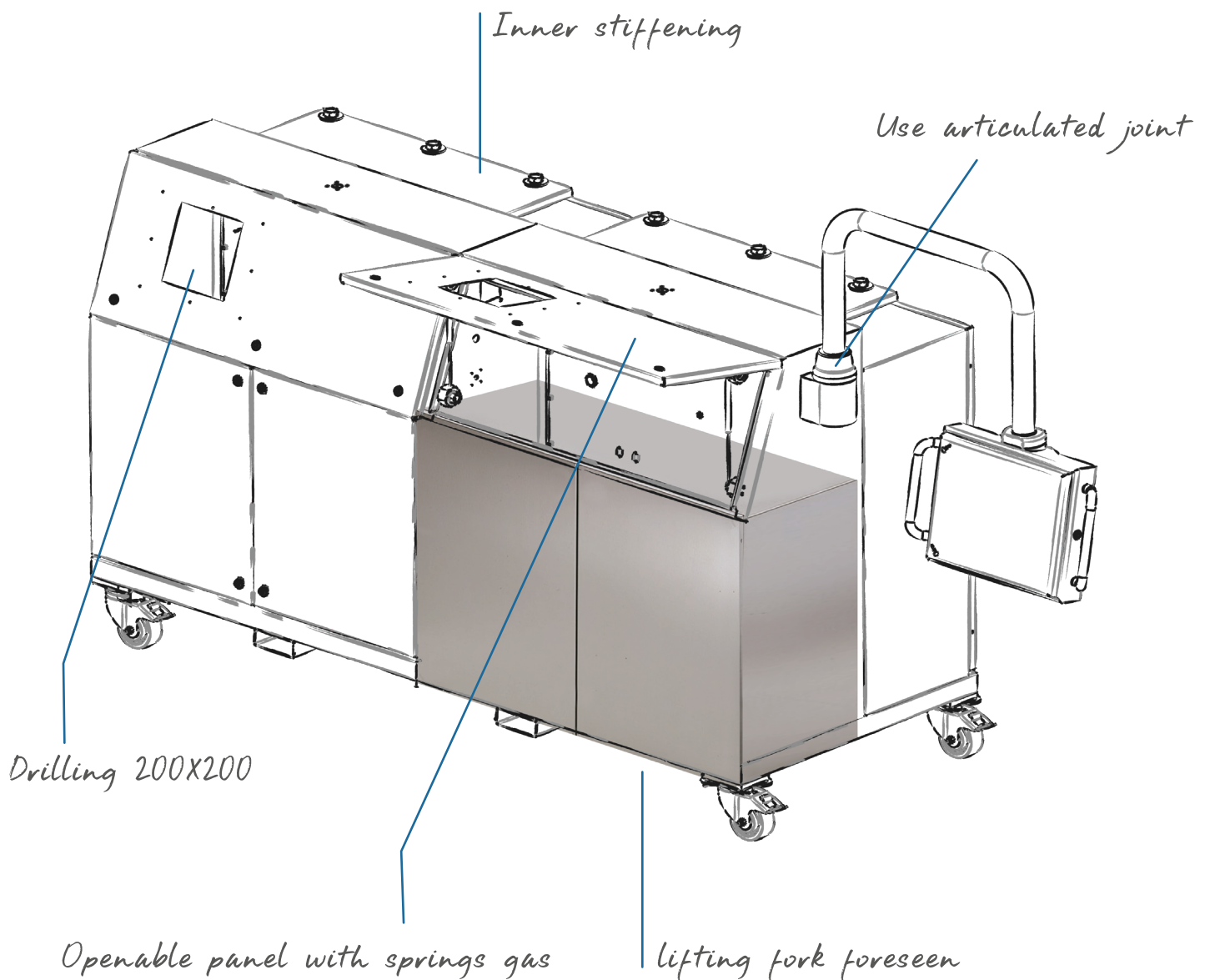

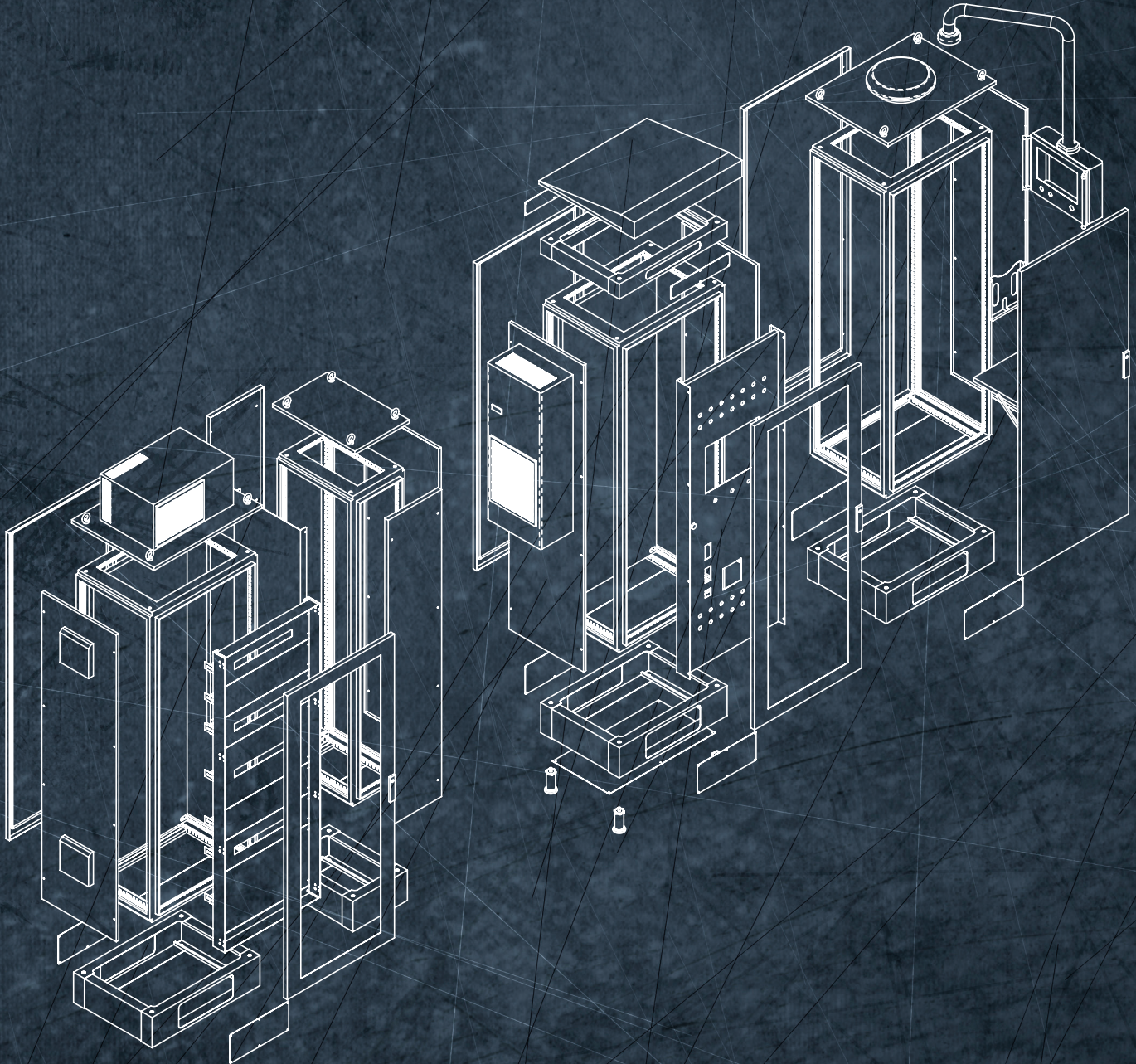

CONTENTS

The new Key for your Business



- 1 CABINETS**
- MODULAR CABINETS** pag. 11
Modular cabinets MX
Accessories for modular cabinets MX
- MONOBLOC CABINET** pag. 27
Monobloc cabinets CX-A
Accessories for monobloc cabinets CX-A
- COMPACT CABINETS** pag. 39
Compact cabinets CC
Accessories for compact cabinets CC
- CABINET ACCESSORIES** pag. 49
Earthquake Kit Components
Cabling system SRS
Accessories for cabinets
Distribution boards
Accessories for distribution boards
- 2 COMPUTER CABINETS & LECTERNS**
- COMPUTER CABINETS & LECTERNS** pag. 69
Computer cabinets APC
Accessories for computer cabinets
Console CS
Lecterns QP
Accessories for lecterns
- 3 SMALL CABINETS** pag. 83
- SMALL CABINETS**
Small cabinets QL
Small cabinets QV
Small cabinets QLP
Small cabinets QVP
Small cabinets QLSE
Small cabinets QS
Small cabinets QM
Accessories for small cabinet
- 4 PUSH-BUTTON BOARDS & JUNCTION BOXES** pag. 109
- PUSH-BUTTON BOARDS & JUNCTION BOXES**
Pushbutton boards PE and Junction boxes DE
Pushbutton boards PS and Junction boxes DS
Accessories for DS and PS
- 5 CONTROL BOX & HANGING SYSTEMS** pag. 117
- CONTROL BOX & HANGING SYSTEMS**
Control box BK
Articulated arms
Hanging systems
- 6 IECEx ATEX LINE** pag. 127
- IECEx ATEX LINE**
Directive 2014/34/UE "ATEX"
Cabinets QL-EX
Small cabinets QLP-EX
Connectors DS-EX
- 7 HYGIENIC DESIGN LINE** pag. 141
- HYGIENIC DESIGN LINE**
Small cabinets QSH
Junction boxes DEH and pushbutton boards PEH
Control box BKH
Cabinets CXH
Accessories for Hygienic Design Line
- 8 AIR CONDITIONING** pag. 157
- AIR CONDITIONING LINE**
Choosing the air conditioning system
Wall-mount air conditioners KJ
Fans and filters KV – KG
Protection casings KL
Roof-mount ventilation units KR
Condensate prevention heaters RH
Room thermostats KS-KT

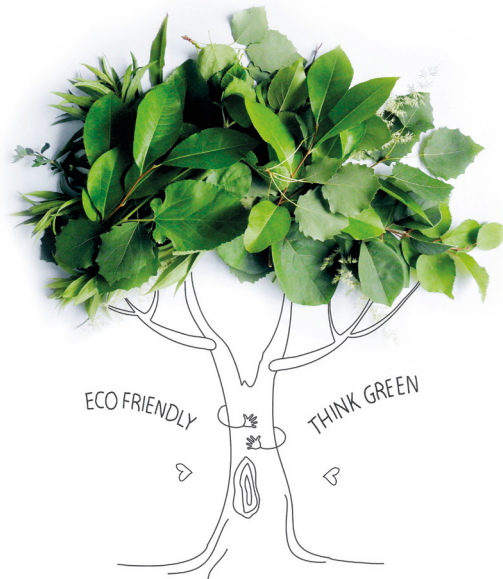

We improve our products without jeopardizing the environment.

Environmentally-friendly solutions.

Ilinox commitment to limiting consumptions throughout the various production steps, reducing pollution thus defending the environment while always and constantly guaranteeing the product performance.

PRODUCT	PAG.
MODULAR CABINETS	
Modular cabinets MX	12
Accessories for modular cabinets MX	22

1

MODULAR CABINETS

MX - THE MODULAR CABINET COMES WITH TWO OPTIONS

Pre-assembled or in a kit? You choose, according to your needs!

MX is the new fully modular cabinet, even more versatile, closer to your needs, that can be delivered either in assembling kit or preassembled and customized.

Ilinox has engineered a system comprised of s/s structural sections and precision castings, that enable you to assemble your frame yourselves!

Component assembling is simple, quick, user's friendly and keeps unaltered the traditional characteristics of stiffness, tightness and sturdiness that have always been the hallmark of Ilinox traditional modular cabinet.

1



2

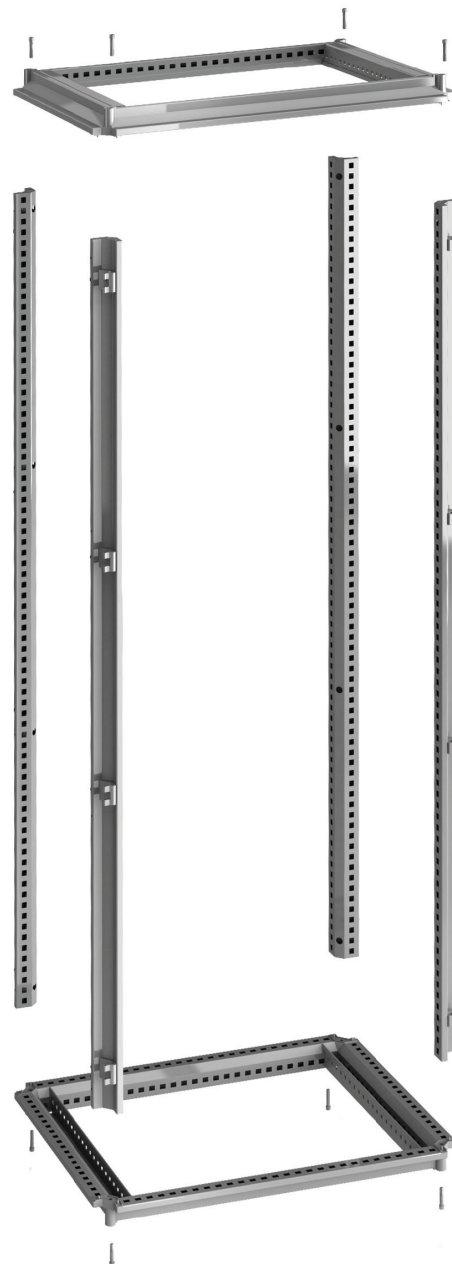

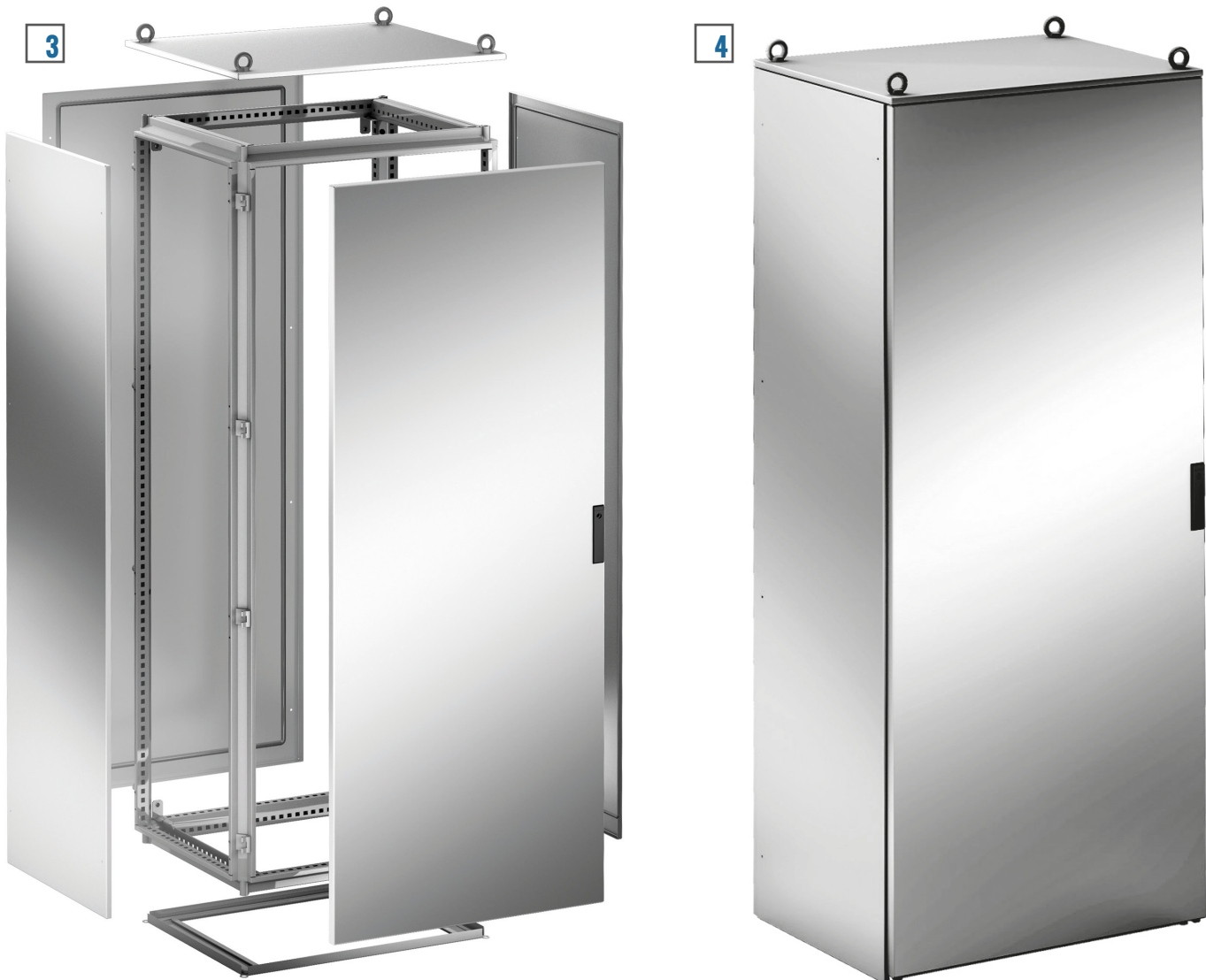

Why in assembling kit? Because this solution permits prompt delivery, smaller overall dimensions hence lower transport and storage costs. Also, customer is free to manage the cabinet directly, besides being more cost-effective compared to the pre-assembled solution.

You anyhow prefer the pre-assembled and customized version? No problem, you just ask for assembling. In this case, the cabinet will not come from our stock, but will be delivered in its traditional version, pre-assembled and drilled, if the need be.

Obviously, all the accessories required for the full exploitation of the MX modular cabinet are available as usual. Whatever your need, the MX cabinet is prepared to meet it: in assembling kit or pre-assembled, then? That's your choice!



PARTITION BAFFLES



REAR DOORS



OVER-DOORS



SKIRTING



- Material: EN 1.4307 (TYPE 304L), finely satin-finished and protected, thickness 15/10 for the side and back panels, 20/10 for frame and door.
- Frame: jointing system realized with precision casting and s/s section bars with drills spaced 25mm for fitting any accessory.
- Supplied in assembling kit or pre-assembled, on demand.
- Front door, full or glazed version (shatterproof 3+3 laminate glass), with s/s stiffening inner frame, drilled to support equipment and/or fasten raceways and accessories. On request the full door can also be equipped with partial windows, or realized with other materials (polycarbonate or aluminium for silk printing).
- Rear side: the cabinet can have a full rear panel, bolted, with sealing spacers, or a hinged door like the front one.
- Side panels, removable and bolted, to be ordered separately (see "Accessories for cabinets").
- Twin-comb door lock with outside faceplate of glass-filled black polyamides, 4-point closing and low tension. Other types of door locks available on request.
- The cabinet bottom can accommodate three different types of fairlead plates: enbloc, multiple or sash-type multiple, to be ordered separately (see accessories for cabinets).
- TYPE 316 s/s inner hinges, for 120° opening as per CEI EN 60204-1 recommendations.
- Seal of foamed polyurethane, applied by robotized system.
- Inner plate, sendzimir execution, to be ordered separately, available both in the traditional and the space saving version (larger). Intermediate plates, sendzimir execution, are available on request.
- Pre-arranged for earthing in compliance with the applicable regulations in force.
- Protection degree: IP66 (IP65 for modules L.1200).
- NOTE: Cabinet delivered in assembling kit, pre-assembled version available on request.

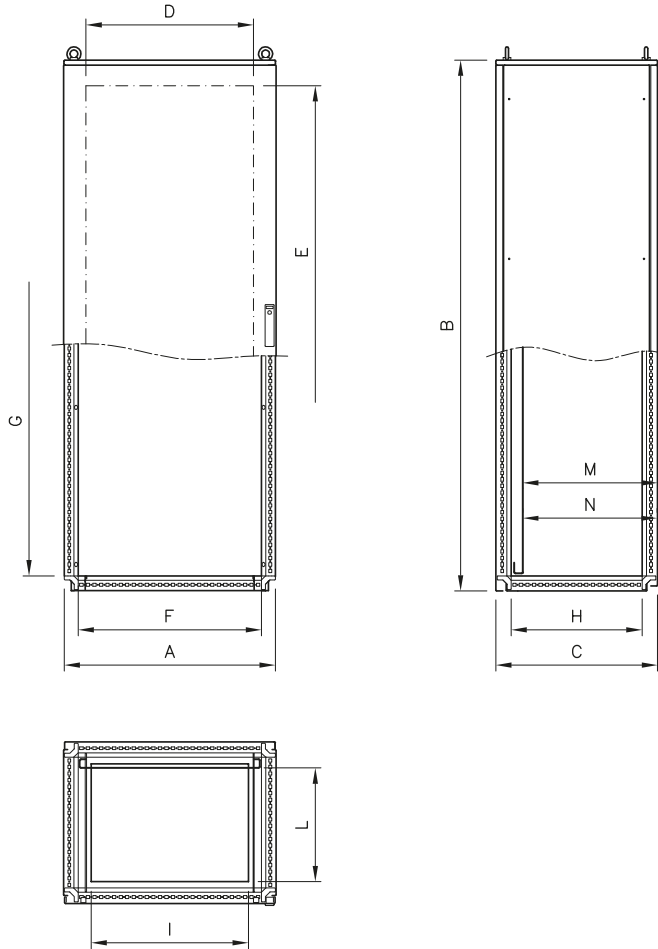

Single blind door module

mechanically tested by  UNIVERSITÀ DEGLI STUDI DI PARMA
Facoltà di Ingegneria

IP66 EN 60 529

UL US LISTED
FILE N° E237618

TYPE NEMA 4X, 4, 12, 1

Standard UL508A - UL50
Standard 250

CE

IK10

EN 60204-1
89/392/EEC

To request your CABINET in an assembling kit, just add a **K** after the code (e.g. MX0685K)

ITEM	CABINET													OPTIONALS			
	OUTSIDE SIZES			DOOR USEFUL SURFACE		FRAME INSIDE SIZES			CABLE WAY		USEFUL DEPTH		USEFUL SPACE	INNER PLATE			SIDES
	A	B	C	D	E	F	G	H	I	L	M**	N*	DRILLING SIDES	ITEM	X	Y	ITEM
MX0685	606	1827	518	440	1630	500	1712	400	400	350	460	424	390	PA0517	497	1692	MX85
MX0686	606	1827	618	440	1630	500	1712	500	400	450	560	524	490	PA0517	497	1692	MX86
MX0688	606	1827	818	440	1630	500	1712	700	400	650	760	724	690	PA0517	497	1692	MX88
MX0885	806	1827	518	640	1630	700	1712	400	600	350	460	424	390	PA0717	697	1692	MX85
MX0886	806	1827	618	640	1630	700	1712	500	600	450	560	524	490	PA0717	697	1692	MX86
MX0888	806	1827	818	640	1630	700	1712	700	600	650	760	724	690	PA0717	697	1692	MX88
MX1085	1006	1827	518	840	1630	900	1712	400	800	350	460	424	390	PA0917	897	1692	MX85
MX1086	1006	1827	618	840	1630	900	1712	500	800	450	560	524	490	PA0917	897	1692	MX86
MX1088	1006	1827	818	840	1630	900	1712	700	800	650	760	724	690	PA0917	897	1692	MX88
MX0605	606	2027	518	440	1830	500	1912	400	400	350	460	424	390	PA0519	497	1892	MX05
MX0606	606	2027	618	440	1830	500	1912	500	400	450	560	524	490	PA0519	497	1892	MX06
MX0608	606	2027	818	440	1830	500	1912	700	400	650	760	724	690	PA0519	497	1892	MX08
MX0805	806	2027	518	640	1830	700	1912	400	600	350	460	424	390	PA0719	697	1892	MX05
MX0806	806	2027	618	640	1830	700	1912	500	600	450	560	524	490	PA0719	697	1892	MX06
MX0808	806	2027	818	640	1830	700	1912	700	600	650	760	724	690	PA0719	697	1892	MX08
MX1005	1006	2027	518	840	1830	900	1912	400	800	350	460	424	390	PA0919	897	1892	MX05
MX1006	1006	2027	618	840	1830	900	1912	500	800	450	560	524	490	PA0919	897	1892	MX06
MX1008	1006	2027	818	840	1830	900	1912	700	800	650	760	724	690	PA0919	897	1892	MX08

** M = maximum depth with inner plate fitted flush inside the frame
* N = maximum depth with inner plate fitted using the slide guides
UL certification to be requested with the order

NOTES: width with side panels fitted = A + 5 mm

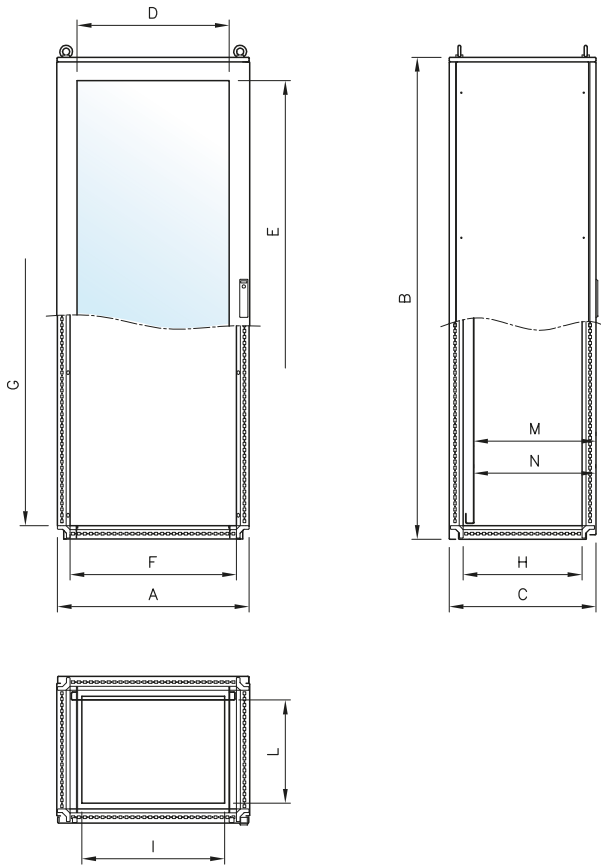

Glazed single door module

mechanically tested by  UNIVERSITÀ DEGLI STUDI DI PARMA
Facoltà di Ingegneria

IP66 EN 60 529

UL US LISTED
FILE N° E237618

TYPE NEMA 4X, 4, 12, 1

Standard UL508A - UL50
Standard 250

CE

EN 60204-1
89/392/EEC

To request your CABINET in an assembling kit, just add a K after the code (e.g. MXV0685K)

ITEM	CABINET													OPTIONALS			
	OUTSIDE SIZES			DOOR VISIBLE		FRAME INSIDE SIZES			CABLE WAY		USEFUL DEPTH		USEFUL SPACE	INNER PLATE			SIDES
	A	B	C	D	E	F	G	H	I	L	M**	N*	DRILLING SIDES	ITEM	X	Y	ITEM
MXV0685	606	1827	518	400	1600	500	1712	400	400	350	454	418	390	PA0517	497	1692	MX85
MXV0686	606	1827	618	400	1600	500	1712	500	400	450	554	518	490	PA0517	497	1692	MX86
MXV0688	606	1827	818	400	1600	500	1712	700	400	650	754	718	690	PA0517	497	1692	MX88
MXV0885	806	1827	518	600	1600	700	1712	400	600	350	454	418	390	PA0717	697	1692	MX85
MXV0886	806	1827	618	600	1600	700	1712	500	600	450	554	518	490	PA0717	697	1692	MX86
MXV0888	806	1827	818	600	1600	700	1712	700	600	650	754	718	690	PA0717	697	1692	MX88
MXV1085	1006	1827	518	800	1600	900	1712	400	800	350	454	418	390	PA0917	897	1692	MX85
MXV1086	1006	1827	618	800	1600	900	1712	500	800	450	554	518	490	PA0917	897	1692	MX86
MXV1088	1006	1827	818	800	1600	900	1712	700	800	650	754	718	690	PA0917	897	1692	MX88
MXV0605	606	2027	518	400	1800	500	1912	400	400	350	454	418	390	PA0519	497	1892	MX05
MXV0606	606	2027	618	400	1800	500	1912	500	400	450	554	518	490	PA0519	497	1892	MX06
MXV0608	606	2027	818	400	1800	500	1912	700	400	650	754	718	690	PA0519	497	1892	MX08
MXV0805	806	2027	518	600	1800	700	1912	400	600	350	454	418	390	PA0719	697	1892	MX05
MXV0806	806	2027	618	600	1800	700	1912	500	600	450	554	518	490	PA0719	697	1892	MX06
MXV0808	806	2027	818	600	1800	700	1912	700	600	650	754	718	690	PA0719	697	1892	MX08
MXV1005	1006	2027	518	800	1800	900	1912	400	800	350	454	418	390	PA0919	897	1892	MX05
MXV1006	1006	2027	618	800	1800	900	1912	500	800	450	554	518	490	PA0919	897	1892	MX06
MXV1008	1006	2027	818	800	1800	900	1912	700	800	650	754	718	690	PA0919	897	1892	MX08

** M = maximum depth with inner plate fitted flush inside the frame
* N = maximum depth with inner plate fitted using the slide guides
UL certification to be requested with the order

NOTES: width with side panels fitted = A + 5 mm

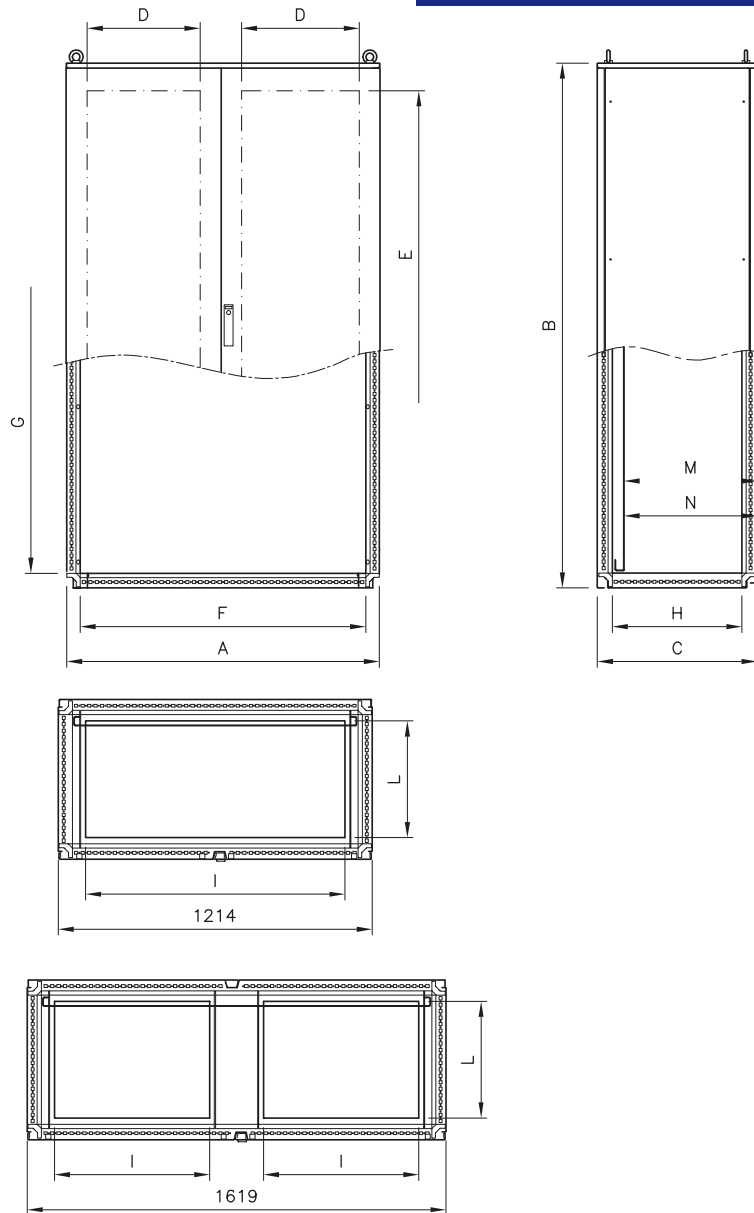

Double blind door module

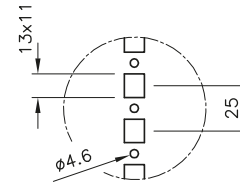

mechanically tested by  UNIVERSITÀ DEGLI STUDI DI PARMA
Facoltà di Ingegneria

IP66 EN 60 529

UL US LISTED
FILE N° E237618

TYPE NEMA 4X, 12, 1, 4

Standard UL508A - UL50
Standard 250

CE

EN 60204-1
89/392/EEC

To request your CABINET in an assembling kit, just add a **K** after the code (e.g. MX1285K)

ITEM	CABINET													OPTIONALS			
	OUTSIDE SIZES			DOOR USEFUL SURFACE		FRAME INSIDE SIZES			CABLE WAY		USEFUL DEPTH		USEFUL SPACE	INNER PLATE			SIDES
	A	B	C	D	E	F	G	H	I	L	M**	N*	DRILLING SIDES	ITEM	X	Y	ITEM
MX1285	1209	1827	518	440	1630	1103	1712	400	1003	350	460	424	390	PA1117	1100	1692	MX85
MX1286	1209	1827	618	440	1630	1103	1712	500	1003	450	560	524	490	PA1117	1100	1692	MX86
MX1288	1209	1827	818	440	1630	1103	1712	700	1003	650	760	724	690	PA1117	1100	1692	MX88
MX1685	1614	1827	518	640	1630	1508	1712	400	600	350	460	424	390	PA1517	1505	1692	MX85
MX1686	1614	1827	618	640	1630	1508	1712	500	600	450	560	524	490	PA1517	1505	1692	MX86
MX1688	1614	1827	818	640	1630	1508	1712	700	600	650	760	724	690	PA1517	1505	1692	MX88
MX1205	1209	2027	518	440	1830	1103	1912	400	1003	350	460	424	390	PA1119	1100	1892	MX05
MX1206	1209	2027	618	440	1830	1103	1912	500	1003	450	560	524	490	PA1119	1100	1892	MX06
MX1208	1209	2027	818	440	1830	1103	1912	700	1003	650	760	724	690	PA1119	1100	1892	MX08
MX1605	1614	2027	518	640	1830	1508	1912	400	600	350	460	424	390	PA1519	1505	1892	MX05
MX1606	1614	2027	618	640	1830	1508	1912	500	600	450	560	524	490	PA1519	1505	1892	MX06
MX1608	1614	2027	818	640	1830	1508	1912	700	600	650	760	724	690	PA1519	1505	1892	MX08

** M = maximum depth with inner plate fitted flush inside the frame
* N = maximum depth with inner plate fitted using the slide guides
UL certification to be requested with the order

NOTES: width with side panels fitted = A + 5 mm

MODULAR CABINETS SERIES MX

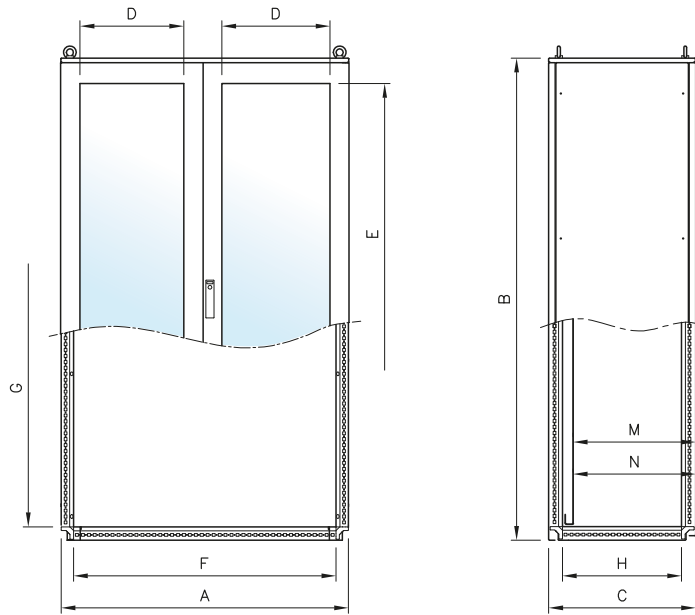

Double glazed door module

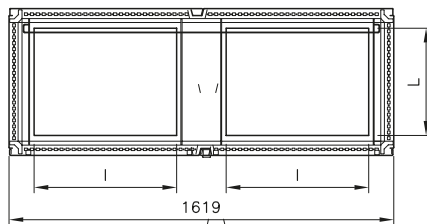
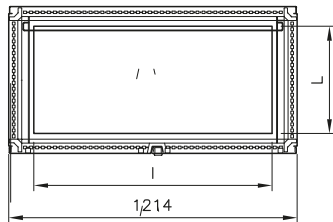
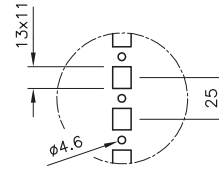

mechanically tested by UNIVERSITÀ DEGLI STUDI DI PARMA
Facoltà di Ingegneria

IP66 EN 60 529

US LISTED
FILE N° E237618

TYPE NEMA 4X, 4, 12, 1

Standard UL508A - UL50
Standard 250

EN 60204-1
89/392/EEC

To request your CABINET in an assembling kit, just add a **K** after the code (e.g. MXV1285K)

ITEM	CABINET												OPTIONALS				
	OUTSIDE SIZES			DOOR VISIBLE	FRAME INSIDE SIZES			CABLE WAY		USEFUL DEPTH		USEFUL SPACE	INNER PLATE			SIDES	
	A	B	C	D	E	F	G	H	I	L	M**	N*	DRILLING SIDES	ITEM	X	Y	ITEM
MXV1285	1209	1827	518	400	1600	1103	1712	400	1003	350	454	418	390	PA1117	1100	1692	MX85
MXV1286	1209	1827	618	400	1600	1103	1712	500	1003	450	554	518	490	PA1117	1100	1692	MX86
MXV1288	1209	1827	818	400	1600	1103	1712	700	1003	650	754	718	690	PA1117	1100	1692	MX88
MXV1685	1614	1827	518	600	1600	1508	1712	400	600	350	454	418	390	PA1517	1505	1692	MX85
MXV1686	1614	1827	618	600	1600	1508	1712	500	600	450	554	518	490	PA1517	1505	1692	MX86
MXV1688	1614	1827	818	600	1600	1508	1712	700	600	650	754	718	690	PA1517	1505	1692	MX88
MXV1205	1209	2027	518	400	1800	1103	1912	400	1003	350	454	418	390	PA1119	1100	1892	MX05
MXV1206	1209	2027	618	400	1800	1103	1912	500	1003	450	554	518	490	PA1119	1100	1892	MX06
MXV1208	1209	2027	818	400	1800	1103	1912	700	1003	650	754	718	690	PA1119	1100	1892	MX08
MXV1605	1614	2027	518	600	1800	1508	1912	400	600	350	454	418	390	PA1519	1505	1892	MX05
MXV1606	1614	2027	618	600	1800	1508	1912	500	600	450	554	518	490	PA1519	1505	1892	MX06
MXV1608	1614	2027	818	600	1800	1508	1912	700	600	650	754	718	690	PA1519	1505	1892	MX08

** M = maximum depth with inner plate fitted flush inside the frame
* N = maximum depth with inner plate fitted using the slide guides
UL certification to be requested with the order

NOTES: width with side panels fitted = A + 5mm

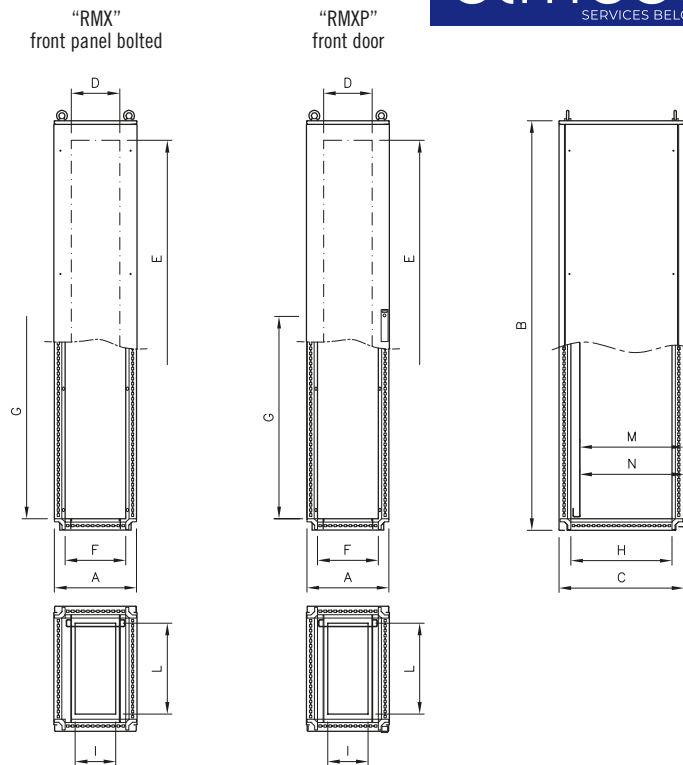

Cable riser module

mechanically tested by UNIVERSITÀ DEGLI STUDI DI PARMA
Facoltà di Ingegneria

IP66 EN 60 529

UL US LISTED
FILE N° E237618

TYPE NEMA 4X, 12, 1, 4

Standard UL508A - UL50
Standard 250

CE

IK10

EN 60204-1
89/392/EEC

To request your CABINET in an assembling kit, just add a K after the code (e.g. RMX0385K)

ITEM	CABINET									OPTIONALS							
	OUTSIDE SIZES			DOOR USEFUL SURFACE		FRAME INSIDE SIZES			CABLE WAY		USEFUL DEPTH		USEFUL SPACE	INNER PLATE		SIDES	
	A	B	C	D	E	F	G	H	I	L	M**	N*	DRILLING SIDES	ITEM	X	Y	ITEM
RMX0385	306	1827	518	180	1690	200	1712	400	100	350	460	424	390	PA0217	197	1692	MX85
RMX0386	306	1827	618	180	1690	200	1712	500	100	450	560	524	490	PA0217	197	1692	MX86
RMX0388	306	1827	818	180	1690	200	1712	700	100	650	760	724	690	PA0217	197	1692	MX88
RMX0485	406	1827	518	280	1690	300	1712	400	200	350	460	424	390	PA0317	297	1692	MX85
RMX0486	406	1827	618	280	1690	300	1712	500	200	450	560	524	490	PA0317	297	1692	MX86
RMX0488	406	1827	818	280	1690	300	1712	700	200	650	760	724	690	PA0317	297	1692	MX88
RMX0305	306	2027	518	180	1890	200	1912	400	100	350	460	424	390	PA0219	197	1892	MX05
RMX0306	306	2027	618	180	1890	200	1912	500	100	450	560	524	490	PA0219	197	1892	MX06
RMX0308	306	2027	818	180	1890	200	1912	700	100	650	760	724	690	PA0219	197	1892	MX08
RMX0405	406	2027	518	280	1890	300	1912	400	200	350	460	424	390	PA0319	297	1892	MX05
RMX0406	406	2027	618	280	1890	300	1912	500	200	450	560	524	490	PA0319	297	1892	MX06
RMX0408	406	2027	818	280	1890	300	1912	700	200	650	760	724	690	PA0319	297	1892	MX08
RMXP0385	306	1827	518	180	1690	200	1712	400	100	350	460	424	390	PA0217	197	1692	MX85
RMXP0386	306	1827	618	180	1690	200	1712	500	100	450	560	524	490	PA0217	197	1692	MX86
RMXP0388	306	1827	818	180	1690	200	1712	700	100	650	760	724	690	PA0217	197	1692	MX88
RMXP0485	406	1827	518	280	1690	300	1712	400	200	350	460	424	390	PA0317	297	1692	MX85
RMXP0486	406	1827	618	280	1690	300	1712	500	200	450	560	524	490	PA0317	297	1692	MX86
RMXP0488	406	1827	818	280	1690	300	1712	700	200	650	760	724	690	PA0317	297	1692	MX88
RMXP0305	306	2027	518	180	1890	200	1912	400	100	350	460	424	390	PA0219	197	1892	MX05
RMXP0306	306	2027	618	180	1890	200	1912	500	100	450	560	524	490	PA0219	197	1892	MX06
RMXP0308	306	2027	818	180	1890	200	1912	700	100	650	760	724	690	PA0219	197	1892	MX08
RMXP0405	406	2027	518	280	1890	300	1912	400	200	350	460	424	390	PA0319	297	1892	MX05
RMXP0406	406	2027	618	280	1890	300	1912	500	200	450	560	524	490	PA0319	297	1892	MX06
RMXP0408	406	2027	818	280	1890	300	1912	700	200	650	760	724	690	PA0319	297	1892	MX08

** M = maximum depth with inner plate fitted flush inside the frame

* N = maximum depth with inner plate fitted using the slide guides

UL certification to be requested with the order

NOTES: width with side panels fitted = A + 5mm

MODULAR CABINETS SERIES MX



MODULE FOR DISCONNECTOR BLOCK

Designed in compliance with the USA safety-related regulations, it allows maximum utilization of the inner spaces, particularly of the whole inner plate, while maintaining accessibility on all sides, which is peculiar to MX modular cabinets.

The module, without inner segregations, features a front door (acting as main door in a battery of cabinets) and a 200mm bolted panel, prearranged to accommodate the control lever of the following master switches:

- Allen Bradley 1494 V-H1
- Square D 9422 A1
- General Electric TDA type 1 and 2
- Moeller NZM-XSHGVR 12-NA
- Siemens ITE MAX FLEX®

Complete with disconnecter interlock - item (A) in the diagram below. This module being usually combined with other modules in a battery, its use must envisage also the use of an interlocks kit, a mechanical system that permits to set the priorities for doors opening:

MKP.IS disconnecter intelock (A)

To lock the door (B in the figure) near to the bolted panel bearing the switch (the door will open only when the latter is set to OFF) inside the module for disconnecter block.

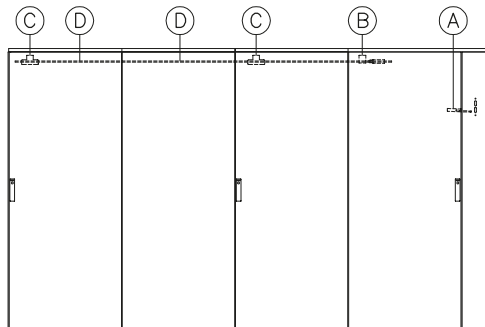

MKP.PR primary interlock (B)

Mechanical drive, including the related transmission lever, to be fitted to the door of the module accommodating the disconnecter block (primary) to command the opening of the doors in the battery-mounted cabinets (secondary).

MKP.SE secondary interlock (C)

To be fitted on all the secondary doors whose opening is slaved to the opening of the primary door; for the double door cabinets, it is to be fitted to the door having priority opening direction (outside door lock) The door opening direction is not binding.



Transmission rods (D)

To transmit the lock or unlock command from the primary door to the secondary ones.

A rod must be ordered per each module except the module for the disconnecter block:

- MKP.AR06 - transmission rod for cabinets nominal width 600 mm.
- MKP.AR08 - transmission rod for cabinets nominal width 800 mm.
- MKP.AR10 - transmission rod for cabinets nominal width 1000 mm.
- MKP.AR12 - transmission rod for cabinets nominal width 1200 mm.
- MKP.AR16 - transmission rod for cabinets nominal width 1600 mm.



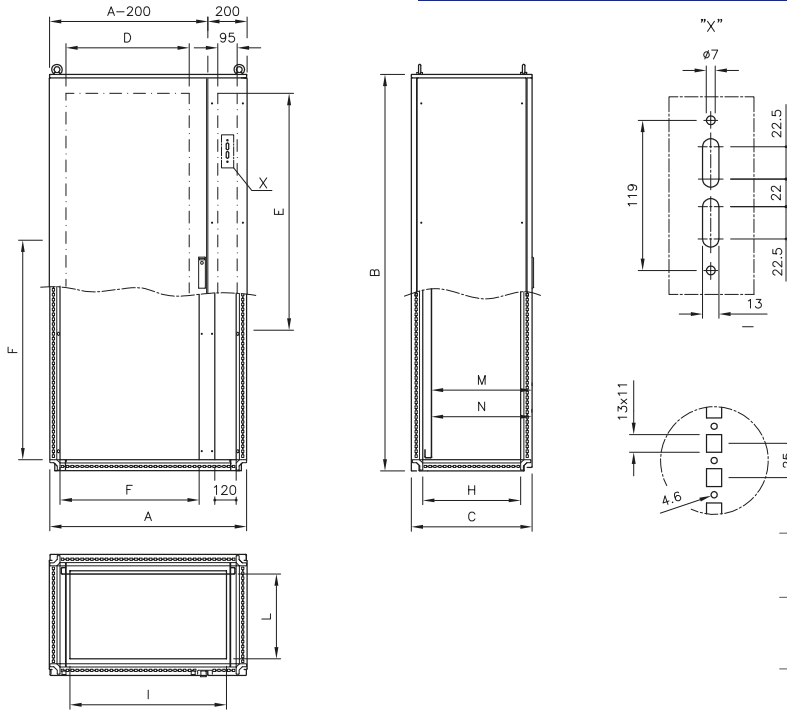

Module for disconnecter block

mechanically tested by UNIVERSITÀ DEGLI STUDI DI PARMA
Facoltà di Ingegneria

IP66 EN 60 529

UL US LISTED
FILE N° E237618

TYPE NEMA 4X, 12, 1, 4

Standard UL508A - UL50
Standard 250

CE

EN 60204-1
89/392/EEC

To request your CABINET in an assembling kit, just add a **K** after the code (e.g. MX0685.200FK)

ITEM	CABINET												OPTIONALS				
	SIZES ESTERNE			DOOR USEFUL SURFACE		FRAME INSIDE SIZES			CABLE WAY		USEFUL DEPTH		USEFUL SPACE DRILLING SIDES	INNER PLATE			SIDES
	A	B	C	D	E	F	G	H	I	L	M**	N*		ITEM	X	Y	
MX0685.200F	606	1827	518	240	1630	300	1712	400	400	350	460	424	390	PA0517	497	1692	MX85
MX0686.200F	606	1827	618	240	1630	300	1712	500	400	450	560	524	490	PA0517	497	1692	MX86
MX0688.200F	606	1827	818	240	1630	300	1712	700	400	650	760	724	690	PA0517	497	1692	MX88
MX0885.200F	806	1827	518	440	1630	500	1712	400	600	350	460	424	390	PA0717	697	1692	MX85
MX0886.200F	806	1827	618	440	1630	500	1712	500	600	450	560	524	490	PA0717	697	1692	MX86
MX0888.200F	806	1827	818	440	1630	500	1712	700	600	650	760	724	690	PA0717	697	1692	MX88
MX1085.200F	1006	1827	518	640	1630	700	1712	400	800	350	460	424	390	PA0917	897	1692	MX85
MX1086.200F	1006	1827	618	640	1630	700	1712	500	800	450	560	524	490	PA0917	897	1692	MX86
MX1088.200F	1006	1827	818	640	1630	700	1712	700	800	650	760	724	690	PA0917	897	1692	MX88
MX1285.200F	1209	1827	518	843	1630	903	1712	400	1003	350	460	424	390	PA1117	1100	1692	MX85
MX1286.200F	1209	1827	618	843	1630	903	1712	500	1003	450	560	524	490	PA1117	1100	1692	MX86
MX1288.200F	1209	1827	818	843	1630	903	1712	700	1003	650	760	724	690	PA1117	1100	1692	MX88
MX0605.200F	606	2027	518	240	1830	300	1912	400	400	350	460	424	390	PA0519	497	1892	MX05
MX0606.200F	606	2027	618	240	1830	300	1912	500	400	450	560	524	490	PA0519	497	1892	MX06
MX0608.200F	606	2027	818	240	1830	300	1912	700	400	650	760	724	690	PA0519	497	1892	MX08
MX0805.200F	806	2027	518	440	1830	500	1912	400	600	350	460	424	390	PA0719	697	1892	MX05
MX0806.200F	806	2027	618	440	1830	500	1912	500	600	450	560	524	490	PA0719	697	1892	MX06
MX0808.200F	806	2027	818	440	1830	500	1912	700	600	650	760	724	690	PA0719	697	1892	MX08
MX1005.200F	1006	2027	518	640	1830	700	1912	400	800	350	460	424	390	PA0919	897	1892	MX05
MX1006.200F	1006	2027	618	640	1830	700	1912	500	800	450	560	524	490	PA0919	897	1892	MX06
MX1008.200F	1006	2027	818	640	1830	700	1912	700	800	650	760	724	690	PA0919	897	1892	MX08
MX1205.200F	1209	2027	518	843	1830	903	1912	400	1003	350	460	424	390	PA1119	1100	1892	MX05
MX1206.200F	1209	2027	618	843	1830	903	1912	500	1003	450	560	524	490	PA1119	1100	1892	MX06
MX1208.200F	1209	2027	818	843	1830	903	1912	700	1003	650	760	724	690	PA1119	1100	1892	MX08

** M = maximum depth with inner plate fitted flush inside the frame
* N = maximum depth with inner plate fitted using the slide guides
UL certification to be requested with the order

NOTES: width with side panels fitted = A + 5mm

MODULAR CABINETS SERIES MX

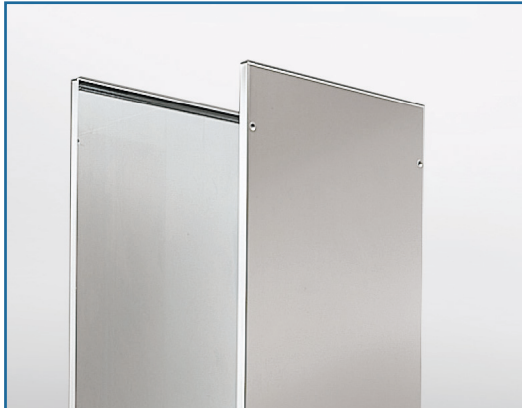

PAIR OF SIDE PANELS

EN 1.4307 (TYPE 304L) s/s execution, finely satin-finished and protected, thickn. 15/10, for direct installation outside the module or to make-up multi-module units, securing them to the frame from the outside by no.8 caphead s/s screws.

FOR CABINETS				
ITEM	SIZES		DEPTH	HEIGHT
	L	H	C	B
MX85	457	1808	518	1827
MX86	557	1808	618	1827
MX88	757	1808	818	1827
MX05	457	2008	518	2027
MX06	557	2008	618	2027
MX08	757	2008	818	2027



MODULE COUPLING KIT MKMX

Indispensable to couple several modules in a battery, it includes the closed cell foam seal, the screws and the special nuts for easy assembling.

- **MKMX** - coupling kit for modules MX

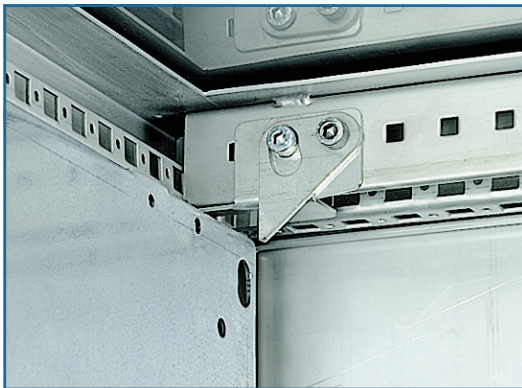

SAFETY STIRRUPS FOR INNER PLATE MKS

Kit formed by 4 shaped squares (2 upper and 2 lower ones), acting as safety lock to prevent the plate being disconnected from the rest by the stress due to transport.

They permit the plate quick connection and its holding the vertical position, while preventing it from overturning during assembling.

- **MKS** - 1 set of squares

NOTE: not to be used with slide guides

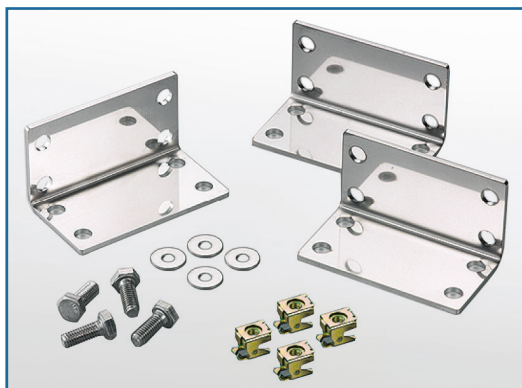

STIFFENING KIT MKIMX

Consisting of 2 formed s/s angle irons with relevant bolts and screws, for application close to the uprights of two coupled frames, to add stiffness and sturdiness to the frame. Its use is always recommended, especially when batteries of several pre-assembled modules already coupled have to be transported and/or when the weight inside the modules exceeds 200 kgs.

- **MKIMX** - Stiffening kits



STEEL SECTIONS SYSTEM

To obtain, easily and quickly, support structures for equipment and instruments accommodated inside the control board; drills spacing 25mm.

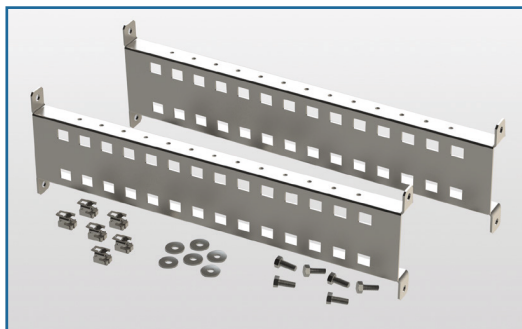

DEPTH CROSS MEMBERS

Section 23x50 mm.

Available for all depth of cabinets, they come complete with screws and fastening stirrup. Can be used to fasten cables, fix bars or as connection between front and rear uprights. Ideal to fix and adjust DIN supports on the depth.

- **CTP05MX** - pair of cross members for MX depth 518
- **CTP06MX** - pair of cross members for MX depth 618
- **CTP08MX** - pair of cross members for MX depth 818

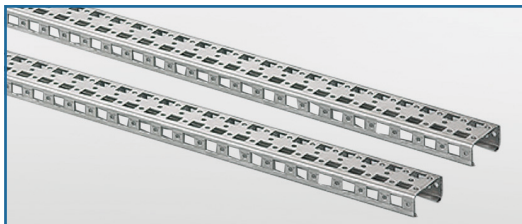

50x25 STEEL SECTIONS BY THE METER PRF502M

Available in 2m bars, to be cut to size to create sturdy cross members or columns. A special stirrup must be ordered for their fixing (code SPRF50)

- **PRF502M** - 2m bar

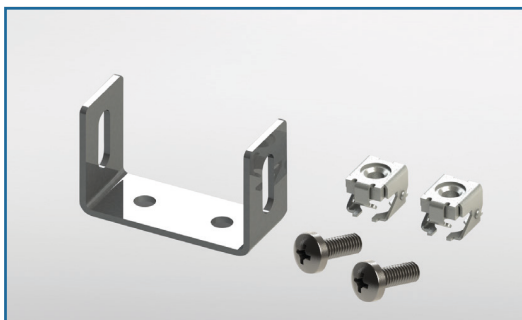

STIRRUP FOR STRUCTURAL STEELS 50x25 SPRF50

Square for fixing the structural steels cut to size. Shape and dimensions have been designed to use the holes close to the upright.

- **SPRF50** - 10 pcs. pack

MODULAR CABINETS SERIES MX



INNER DOORS

EN 1.4307 (TYPE 304L) s/s execution, finely satin-finished and protected, thickness 20/10, delivered in assembling kit, to be used for equipment assembling inside the cabinets.

The distance between inner door and door is adjustable on two depth: 65mm or 110 mm. Can be hinged on the right or left side.

Maximum admitted load 30Kg. Protection degree IP20 (IP54 on demand). Drilling realizable on demand. For cabinets L.1200 and L.1600 use the inner doors of cabinets L.600 or L.800 adding the appropriate upright; in this case, it is advisable not to use the enbloc fairlead plate since it is difficult to remove.

Removable central upright, to be used for installation of inner doors in cabinets L. 1200 and L. 1600.

- **MMX18** - Central upright for cabinets MX height 1827
- **MMX20** - Central upright for cabinets MX height 2027

ITEM	FOR CABINETS			
	SIZES		WIDTH	HEIGHT
	L	H	A	B
CP0618MX	490	1691	606	1827
CP0818MX	690	1691	806	1827
CP1018MX	890	1691	1006	1827
CP0620MX	490	1891	606	2027
CP0820MX	690	1891	806	2027
CP1020MX	890	1891	1006	2027



PARTITION Baffles

EN 10142 sendzimir sheet panel, thickness 25/10, to be set between two modules to keep them apart . Two versions are available : protection degree IP20 and protection degree IP65. On demand they can be drilled for cable passage between two modules, and for connectors.

NOTE: the partition baffle excludes the use of the intermediate plate

ITEM	PROTECTION DEGREE	FOR CABINETS	
		DEPTH	HEIGHT
		C	B
ST285MX	IP20	518	1827
ST286MX	IP20	618	1827
ST288MX	IP20	818	1827
ST205MX	IP20	518	2027
ST206MX	IP20	618	2027
ST208MX	IP20	818	2027
ST685MX	IP65	518	1827
ST686MX	IP65	618	1827
ST688MX	IP65	818	1827
ST605MX	IP65	518	2027
ST606MX	IP65	618	2027
ST608MX	IP65	818	2027

Systems For Modular Switgears



Srs Wiring System

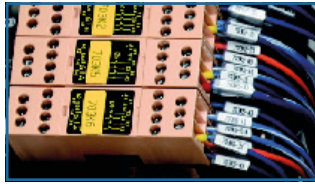

Inner Plates Type PS

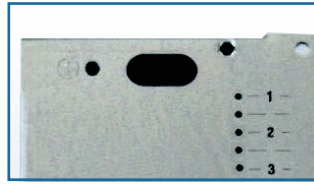

Inner Plates Type PA

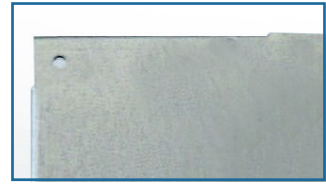

Intermediate Plate



Slide Guides



Transformers Holding Structural Steels

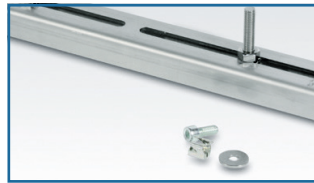

Adjustable Feet



Skirting



Fairlead Plates

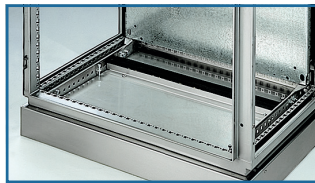

Cable Fixing Cross Members



Cross Members For Door



Work Tabletops



Diagram Holding Pockets

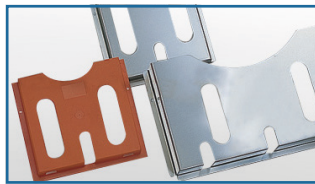

Anti-Close Device



Electroconductive Gaskets

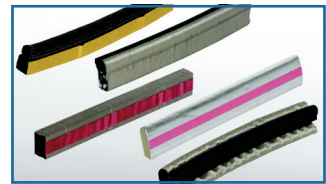

Interlocks



Door Locks Hoisting Bars



Hoisting Eyebolts



Cage Nuts



Self-Tapping Screws 5,5



Lamps

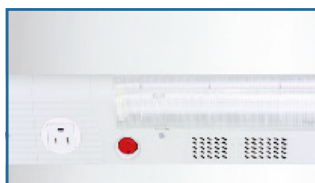

Taps



IN THE SECTION "ACCESSORIES FOR CABINETS"

Over-Doors



Cable Glands



IN THE SECTION "AIR CONDITIONING"

Air Conditioning



Ventilation





Our watchword: Innovation.

Our strength: Research.

We are aware that the quality of the future is dependent on today's Research.

Every year we invest considerable human and financial resources in R&D, to create new technologies and improve the current ones, start projects to optimize the most varied implementations, perform tests on the quality and technological standards of our products.